

SECTION A-A

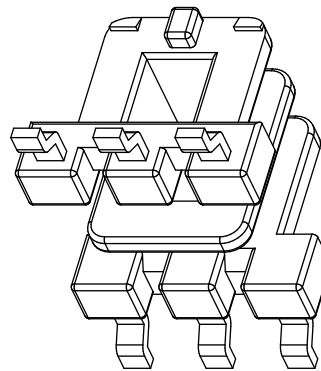
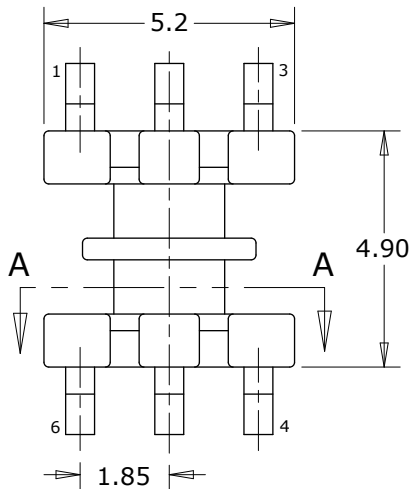
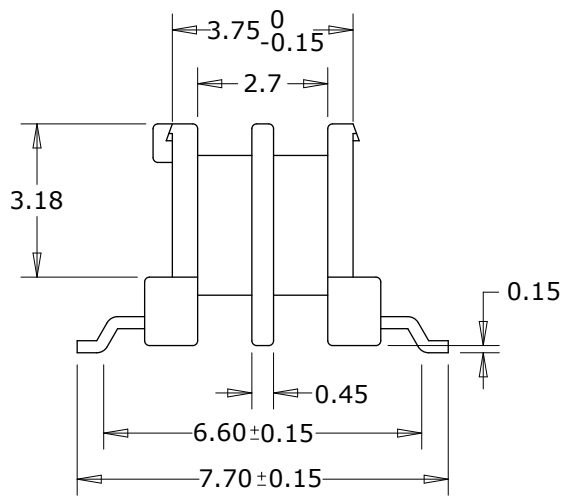
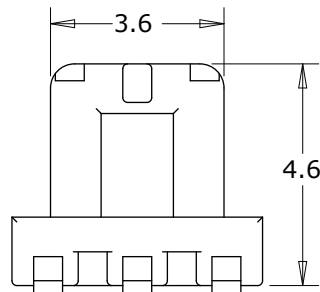
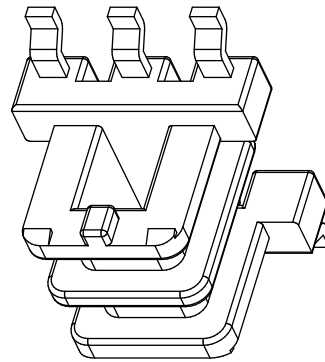

Dimensions in millimetres

DT104 Iss. 3

Coil Former	
Coil former material	Liquid crystal polymer (LCP), glass reinforced, flame retardant in accordance with "UL 94V-0"; UL file number E54705 (M)
Resistance to soldering heat	"IEC 60068-2-20", Part 2, Test Tb, method 1B, 350 deg. C, 3.5 s
Pin material	0.25 x 0.6 Phosphor bronze - Tin (Sn) plated
Solderability	"IEC 60068-2-20", Part 2, Test Ta, method 1, 235 deg. C, 2 s
Pin pull out force	1.5 Kg Minimum
Part number	EE05H2S06GP-00

